

ACVATIX™

Two-port valve PN25 with external threading

VVG549..



In district heating and heating plants with a media temperature up to +130 °C and - with SAT.. actuators - briefly to +150 °C as control or shutoff valve for closed circuits.

- Bronze CuSn5Zn5Pb2
- DN 15...25
- k_{vs} 0.25...6.3 m³/h
- Stroke 5.5 mm
- Flat sealing, externally threaded connections G..B, as per ISO 228-1
- Siemens can deliver fitting sets ALS..2 with welded connection
- Siemens can deliver fitting sets ALS..2, ALG..2B with welded connection
- Can be equipped with electromotoric actuators SSS319, SAS or SAT..

Design

Valve cross-section:

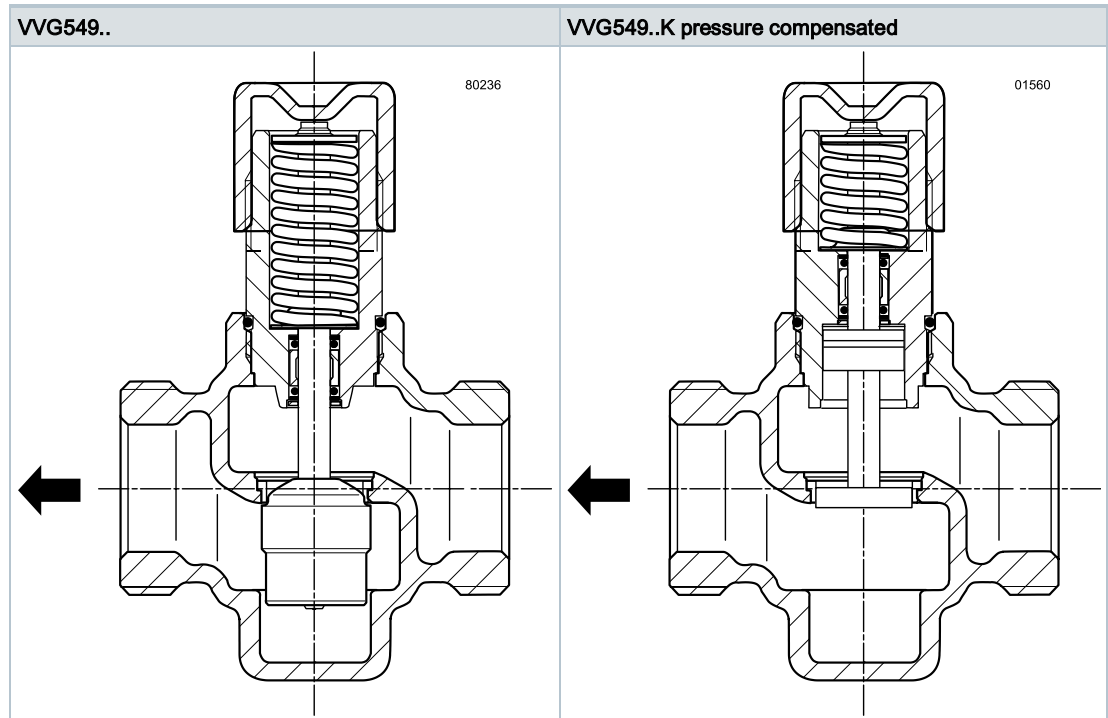

- Valve housing and valve neck (threaded connection, G 3/4B) for installing an electromotoric actuator.
- Sealing gland with two O-rings and dirt protection strip.
- The valves are supplied in a series with a manual adjuster.
- No special tools or adjustments are required to mount the actuator on the valve.

Manual adjustment

The supplied plastic manual adjuster (also acts as the protective cover during transport) can manually adjust the valve in a range from 0...100%.

Turn the manual adjuster clockwise:	Valve open:	Flow rate increases
Turn the manual adjuster counter clockwise:	Valve closes:	Flow decreases

Sizing

Flow diagram:

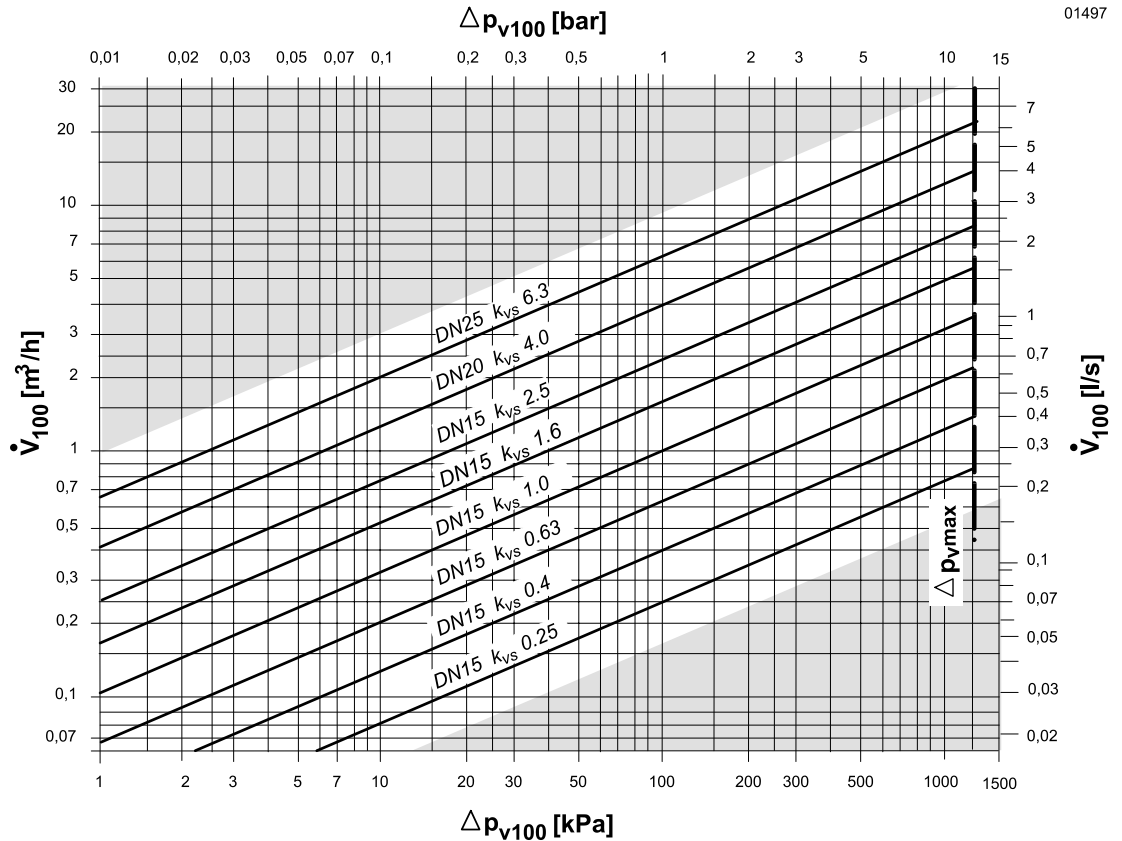

Δp_{max} = Maximum permissible differential pressure over the valve control path, valid for the entire positioning range of the valve-actuator unit:

Δp_{V100} = Differential pressure across the fully open valve and the valve's control path at a volume flow \dot{V}_{100}

\dot{V}_{100} = Volume flow through the fully open valve (H_{100})

100 kPa = 1 bar \approx 10 mWS

1 m³/h = 0.278 l/s water at 20 °C

Valve flow characteristic

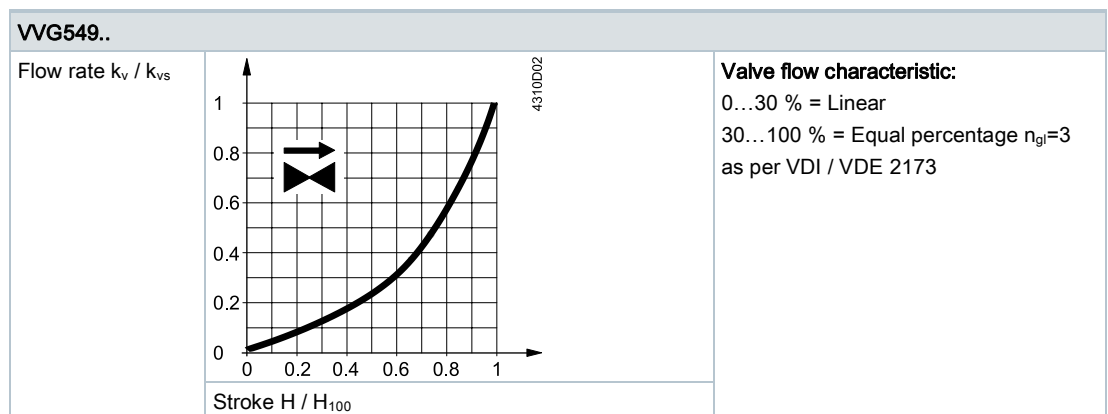

Cavitation

Cavitation increases wear and tear on the valve plug and seat and results in unwanted noise. Cavitation can be prevented by not exceeding the differential pressures as per the flow diagram and maintaining the static pressures depicted below.

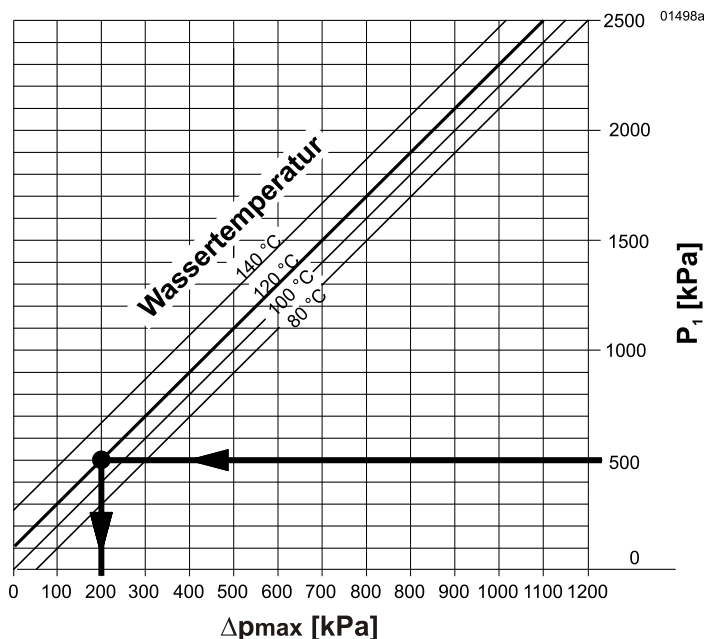

100 kPa = 1 bar @ 10 m WS

Δp_{max} = Differential pressure at a nearly closed valve to largely avoid cavitation

P_1 = Static pressure and the valve inlet

P_2 = Static pressure and the valve outlet

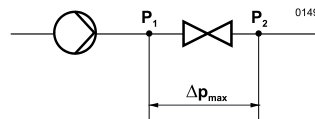

Example with hot water:

Pressure P_1 at valve inlet: 500 kPa (5 bar)

Water temperature: 120 °C

The above diagram clearly indicates that the maximum permissible differential pressure is $\Delta p_{max} \rightarrow 200$ kPa (2 bar) at a nearly closed valve.

Note on chilled water applications

To prevent cavitation in chilled water circuits, sufficient counter pressure must be supplied to the valve output, e.g. using an additional butterfly valve downstream of the valve. Maximum permissible differential pressure over the valve: See 80 °C curve in the above diagram.

Operating pressure and operating temperature

Liquids:

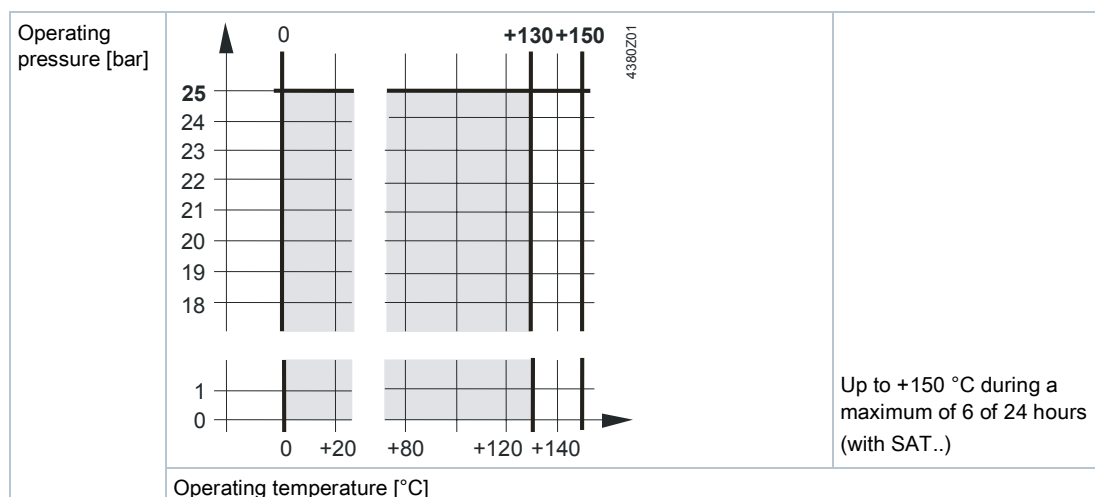

Operating pressure and medium temperature per ISO 7005
(Observe all local and applicable laws).

Type summary

Type	DN	Connecting thread	k_{vs}	S_v
		[inch]	[m ³ /h]	
Standard version				
VVG549.15-0.25	15	G ¾B	0.25	> 50
VVG549.15-0.4			0.4	
VVG549.15-0.63			0.63	
VVG549.15-1			1.0	> 100
VVG549.15-1.6			1.6	
VVG549.15-2.5			2.5	
Pressure compensated				
VVG549.20-4K	20	G 1B	4.0	> 100
VVG549.25-6.3K	25	G 1¼B	6.3	

DN	=	Nominal size
k_{vs}	=	Flow nominal value for cold water (5...30 °C) through a fully opened valve (H100), at a differential pressure of 100 kPa (1 bar)
S_v	=	Rangeability k_{vs} / k_{vr}
k_{vr}	=	Smallest k_v value at which the characteristic curve tolerance is still maintained, at a differential pressure of 100 kPa (1 bar)

Fittings

Type	Stock number	Description
Fittings with threaded connection		
ALG..2	BPZ:ALG..2	2 piece fittings set for 2-port valves, existing of 2 cap nuts, 2 insert nuts, and 2 flat seals. ALG..2B are fittings made of brass for media temperatures up to 100 °C.
ALG..2B	S55846-Z1..	
Fittings with welded connection		
ALS..2	BPZ:ALS..	2 piece on pipe fittings set with welded connection for 2-port valves, existing of 2 cap nuts, 2 insert nuts, and 2 flat seals.

Filter

Installed upstream of the valve:

Type	Stock number	Description	DN	Mesh width [mm]
ALX15	S55845-Z174	Filter with internal threading	15	0.5
ALX20	S55845-Z175	Filter with internal threading	20	0.8
ALX25	S55845-Z176	Filter with internal threading	25	0.8
ALX32	S55845-Z177	Filter with internal threading	32	0.8
ALX40	S55845-Z178	Filter with internal threading	40	0.8
ALX50	S55845-Z179	Filter with internal threading	50	0,8

Equipment combinations

!	NOTICE
	Important: A nominal force of > 250 N required to operate the valves.
	Electromotoric actuators SAS..: In combination with VVG549.. the setting on the DIL switch on SAS.. has to be changed to "ON" = linear. (Factory setting SAS..: All DIL switches set to "OFF" = log/equal-percentage).

Valves	SAS.. actuators ¹⁾		SAT.. actuators	
	Δp_{max}	Δp_s	Δp_{max}	Δp_s
	[kPa]	[kPa]	[kPa]	[kPa]
VVG549.15-0.25	1200	2500	1200	2500
VVG549.15-0.4				
VVG549.15-0.63				
VVG549.15-1		1500		1500
VVG549.15-1.6				
VVG549.15-2.5				
Pressure compensated				
VVG549.20-4K	1200	1600		1600
VVG549.25-6.3K				

¹⁾ SAS.. combined with VVG549: Change setting on the DIL switch to linear (factory setting = log).

Valves	2 piece fitting set			
	Threaded connection			Welded connection
	Malleable cast iron	Brass ¹⁾		Steel
	Type / Item NO.	Type	Item NO.	Type / Item NO.
VVG549.15-0.25	ALG122	ALG142 ¹⁾	ALG142 ¹⁾	ALS152
VVG549.15-0.4				
VVG549.15-0.63				
VVG549.15-1				
VVG549.15-1.6				
VVG549.15-2.5				
Pressure compensated				
VVG549.20-4K	ALG152	ALG152B ²⁾	S55846-Z100 ²⁾	ALS202
VVG549.25-6.3K	ALG202	ALG202B ²⁾	S55846-Z102 ²⁾	ALS252

¹⁾ = With externally threaded connection

²⁾ = Medium temperature: Maximal 100 °C

Δp_{max} = Maximum permissible differential pressure over the valve control path, valid for the entire positioning range of the valve-actuator unit; if low noise operation is desired, we recommend a differential pressure of 200 kPa

Δp_s = Maximum permissible differential pressure (closing pressure) at which the valve-actuator unit securely closes against the pressure

Actuators: Overview

Type	Operating voltage	Positioning		Spring return		Data sheet
		Signal	Time	Function	Time	
SSY319 1)	AC 230 V		150 s			Q4899
SAT31.008			8 s			N4584
SAT31.51			15 s			
SAT61.008	AC/DC 24 V	DC 0...10 V DC 4...20 mA 0...1000 Ω	8 s	-		
SAT61.51			15 s	Yes	<8 s	
SAS31.00	AC 230 V	3-position	120 s	-		N4581
SAS31.03			30 s			
SAS31.50			120 s	Yes	<28 s	
SAS31.53			30 s		<14 s	
SAS61.03 2)	AC/DC 24 V	DC 0...10 V DC 4...20 mA 0...1000 Ω	30 s	-		
SAS61.03U 3)				Yes	<14 s	
SAS61.33 2)						
SAS61.33U 3)						
SAS61.53 2)						
SAS81.00 3)	AC 230 V	3-position	120 s	-		
SAS81.00U 3)			30 s			
SAS81.03 2)						
SAS81.03U 3)						
SAS81.33 2)				Yes	<14 s	
SAS81.33U 3)						

1) SSY319 with 1.5 meter connecting cable

2) Approbation CE+UL

3) Approbation CE+UL, cable gland: ½" (UL514C)

Ordering

Please indicate material, article type, order text, and quantity; example:

Material	Article type	Order text	Quantity
VVG549.25-6.3K	BPZ:VVG549.25-6.3K	Two-port valve PN25 with external threading	15
ALG202B	S55846-Z102	2-piece fittings set made of brass	15
VVG549.20-4K	BPZ:VVG549.20-4K	Two-port valve PN25 with external threading	15
ALS202	ALS202	2-piece fittings set with welded connection	15

Delivery

Valves, rotary actuators, and mounting kits are not assembled and are delivered in individual packaging and without a minimum order size.

Product documentation

Related documents such as environmental declarations, CE declarations, etc., can be downloaded at the following Internet address:

<http://siemens.com/bt/download>

Notes

Safety

	⚠ DANGER
	<p>There is a risk to operating personnel and device when working on the unit Failure to comply with these safety notes can result in personal injury and damage to property from pipe pressure, electrical voltage, or device in operation.</p> <p>▷ Note the following when servicing a valve/actuator:</p> <ul style="list-style-type: none">• Switch off both pump and operating voltage.• Close shutoff valves.• Release pressure in the pipes and allow them to cool down completely.• Disconnect electrical connections from the terminals as needed.• The actuator must be properly installed or manually adjusted prior to recommissioning the valve.

	⚠ CAUTION
	<p>National safety regulations Failure to comply with national safety regulations may result in personal injury and property damage.</p> <ul style="list-style-type: none">• Observe national provisions and comply with the appropriate safety regulations.

Engineering

We recommend installing the valve with spring return since temperatures are lower on heating plants which increases the lifespan of the sealing gland on the stem.

A filter must be installed upstream of the valve to increase functional safety.

Mounting

It is easy to assemble the valve and actuator; it can be done at the construction site. No special tools or settings required.

Valve VVG549.. is supplied with mounting instructions 431901850.

Mounting position

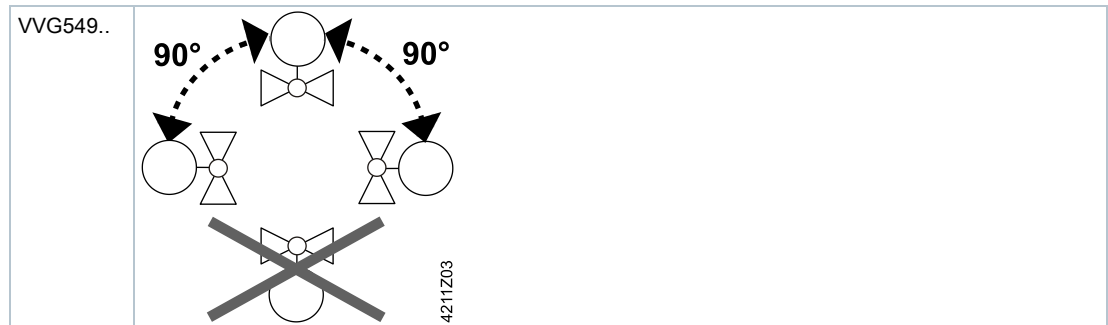

Pipe connection

Avoid leakage:

- Install fittings as per ISO 7-1.
- Do not use too much hemp or PTFE tape.
- Do not tighten pipe threading to "the very end".

Flow direction

Make sure that the valve is mounted in the proper flow direction. A symbol is applied to the valve body:

VVG549.. :

Flow direction:



Commissioning

The actuator must be properly mounted or manually adjusted before commissioning the valve.

VVG549..

Valve stem retracts:

Valve opening = Increasing flow

Valve stem extends:

Valve closing = Decreasing flow

Maintenance

VVG549.. valves are maintenance free.

Stem sealing gland

The stem sealing gland cannot be exchanged. The entire valve must be replaced in the event of leakage. Contact your local Siemens office or branch for information.

Disposal

	⚠ WARNING
	Tensioned return spring Opening the valve housing can release the tensioned return spring resulting in flying parts that may cause injury. <ul style="list-style-type: none">• Do not open the valve body.



The valve is considered electrical and electronic equipment for disposal in terms of the applicable European Directive and may not be disposed of as domestic garbage.

- Dispose of the valve through channels provided for this purpose.
- Comply with all local and currently applicable laws and regulations.

Warranty

Technical data on specific applications are valid only together with Siemens products listed under "Equipment combinations". Siemens rejects any and all warranties in the event that third-party products are used.

Functional data	
PN class	PN 25 per ISO 7268
Operating pressure	2500 kPa (25 bar), ANSI class 250 psi Per ISO 7005 within the permissible media temperature as per Section Technical design [→ 2]
Characteristic curve 0...30 % 30...100 %	Linear equal percentage; $n_{gl} = 3$ per VDI / VDE 2173
Leakage rate	0...0.02 % of k_{vs} value per VDI / VDE 2174
Permissible media	Chilled, warm and hot water, water with anti-frost; water with oxygen-binding additive; water with additives per VDI 2035 Recommendation: Water treatment per VDI 2035
Medium temperature ¹⁾	+2...130 °C (with SAT.. max. 6 of 24 hours at +150 °C) ¹⁾
Rangeability S_v	DN 15: 50, to k_{vs} value 1 m ³ /h, see Section Type summary [→ 5] > DN 15: 100
Nominal stroke	5.5 mm
Manual adjuster	without actuator, manual adjuster: 0...100%

Materials	
Housing	Bronze CuSn5Zn5Pb2
Seat, plug, and stem, and spring	Stainless steel
Sealing gland	Brass
Stem sealing gland	EPDM-O rings

Dimensions / Weight	
See Dimensions [→ 13]	
Threaded connection valve	G..B per ISO 228-1
Threaded connection fittings	Rp.. per ISO 7-1

Standards, directives and approvals	
Pressure Equipment Directive	DGR 2014/68/EU
Pressure accessories	Range: Article 1, para. 1 Definition: Article 2, para. 5
Fluid group 2	Without CE certification as per article 3, para. 3 (generally applicable engineering practice) ²⁾
EAC compliance	Eurasian compliance
Environmental compatibility	Environmental Declaration CE1E4380en ³⁾ contains data on environmental-compatible product design and assessment (RoHS compliance, compositions, packaging, environmental benefits and disposal).

¹⁾ With ALG..B fitting up to 100 °C

²⁾ Fittings for a product where $PS \times DN < 1000$, do not require special testing and cannot have CE labeling

³⁾ See Section Product documentation [→ 9]

Dimensions

All dimensions in mm

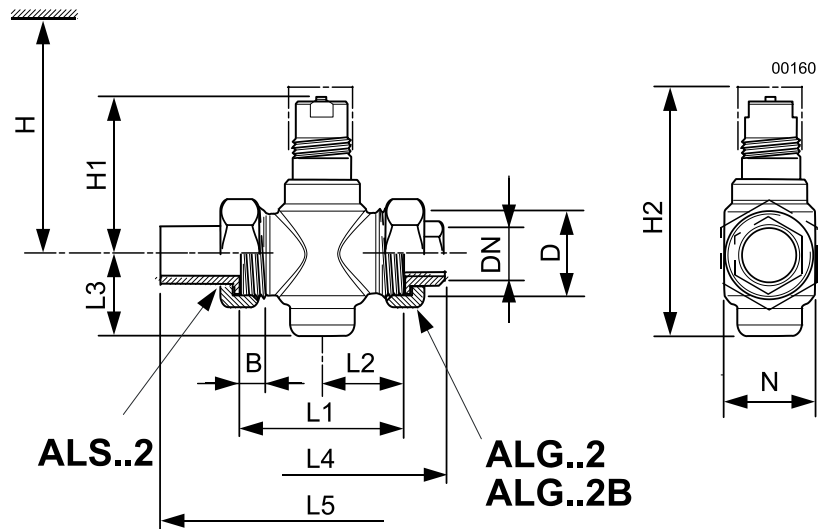

H(*) = Total height of actuator plus minimum mounting distance to wall or ceiling, for mounting, connection, operation, maintenance, etc.

H1 = Resting height for actuator

L4 = Valve length including two fittings ALG..2, ALG..2B

L5 = Valve lengths including two fittings ALG..2

G = Valve weight without fittings in kg, without packaging

G* = Weight in kg, without packaging

ø E = Piping threading diameter Rp.. per ISO 7-1

ø P = Pipe external diameter [mm]

Valve type	DN	D	H	H*	H1	H2	L1	L2	L3	L4	L5	N	B	Weight
		[Zoll]												kg
VVG549.15-0.25	15	G ¾B	212	229	58	97	65	32.5	31.5	111	137	33	11.5	0.48
VVG549.15-0.4														
VVG549.15-0.63														
VVG549.15-1														
VVG549.15-1.6														
VVG549.15-2.5														
VVG549.20-4K	20	G 1B	230	247	78	120	70	35	37.5	117	153	37	12	0.63
VVG549.25-6.3K	25	G 1¼B					75	37.5		123	158	42		0.72

* Together with SAT..

Fittings

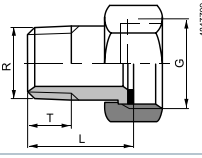
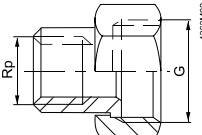
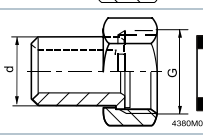
	Type	Article number	For valve type	G	Rp
				[inch]	[inch]
	ALG142	-	-	G ¾	R ½
	ALG122	-	-	G ¾	Rp ¾
	ALG152	ALG152B	S55846-Z100	G 1	Rp ½
	ALG202	ALG202B	S55846-Z102	G 1¼	Rp ¾
	ALS152	-	-	G ¾	21,3
	ALS202	-	-	G 1	26,8
	ALS252	-	-	G 1¼	33,7

Filter

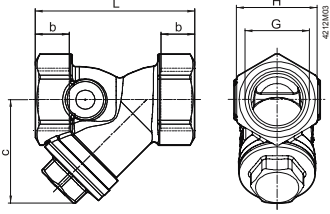
	Type	DN	b	c	G	L	H	Kvs	Weight
			mm	mm	Inch ¹⁾	mm	mm		kg
	ALX15	15	12	38	G ½	54	27	3.5	0.178
	ALX20	20	15	43	G ¾	67	34	5.8	0.290
	ALX25	25	16	53	G 1	79	41	9.1	0.410
	ALX32	31	17	64	G 1¼	98	51	19	0.680
	ALX40	40	18	70	G 1½	106	57	24	0.874
	ALX50	50	20	85	G 2	122	69	36	1.428

¹⁾ ISO 228-1

Replacement parts

Type	Item NO.	Designation	Quantity
74 676 0273 0	74 676 0273 0	Rotary knob for small-stroke valves	10

Revision numbers

Type	Valid from rev. no.
VVG549.15-0.25	../01
VVG549.15-0.4	../01
VVG549.15-0.63	../01
VVG549.15-1	../01
VVG549.15-1.6	../01
VVG549.15-2.5	../01
VVG549.20-4K	../01
VVG549.25-6.3K	../01

Issued by
Siemens Switzerland Ltd
Smart Infrastructure
Global Headquarters
Theilerstrasse 1a
CH-6300 Zug
Tel. +41 58-724 24 24
www.siemens.com/buildingtechnologies

© Siemens Switzerland Ltd, 2016
Technical specifications and availability subject to change without notice.