

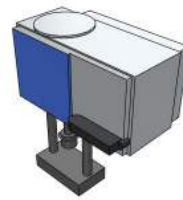

**3Dfindit**

powered by  **CADENAS**



**SIEMENS**

**sqv2020p2020**

# CONTENT

---

Augmented Reality (AR) - Digital meets real	2
3D preview of sqv2020p2020	3
Integrate Siemens Building Technologies EUROPEAN Portfolio catalog inside your CAD System	4
2D derivations and Bill-Of-Material (BOM)	5
Technical drawings	6
Technical data	7
Get a free E-Learning training for Siemens Building Technologies EUROPEAN Portfolio catalog	8



# 3Dfindit

powered by  CADENAS

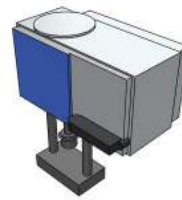

## SIEMENS

### sqv2020p2020

## AR

Augmented Reality, often shortened to AR, is a technology that blends digital information into the real world. For more information, please click [here](#) or directly try yourself by scanning the QR code with your phone.

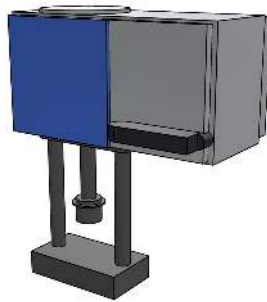

Please scan the QR code above and open on AR-enabled device.

There is a possibility that the configuration will fail. If that happens, please try a different product.



# 3Dfindit

powered by  CADENAS

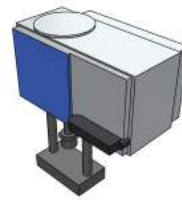

## SIEMENS

### sqv2020p2020

## 3D view

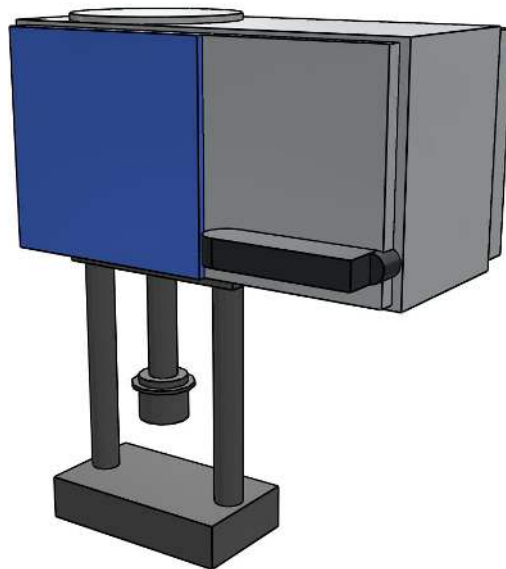

## HOW TO ACTIVATE 3D?

To activate the interactive 3D view in Acrobat Reader, you need to select, at the top of the page, **Options** and then **Trust this document**

### Zoom

Moves you toward or away from objects in the scene when you drag vertically. You can also zoom with the hand tool by holding down Shift as you drag.

### Pan

Moves the model vertically and horizontally only. You can also pan with the hand tool: Ctrl-drag.

### Rotate

Turns 3D objects around relative to the screen. How the objects move depends on the starting view, where you start dragging and the direction in which you drag.



# 3Dfindit

powered by CADENAS

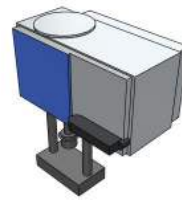

# SIEMENS

## sqv2020p2020

## CAD plugins

With our CAD integrations, you can use 3Dfindit directly in your CAD system and make your work easier with additional comfort functions, such as replacing a part and many more.

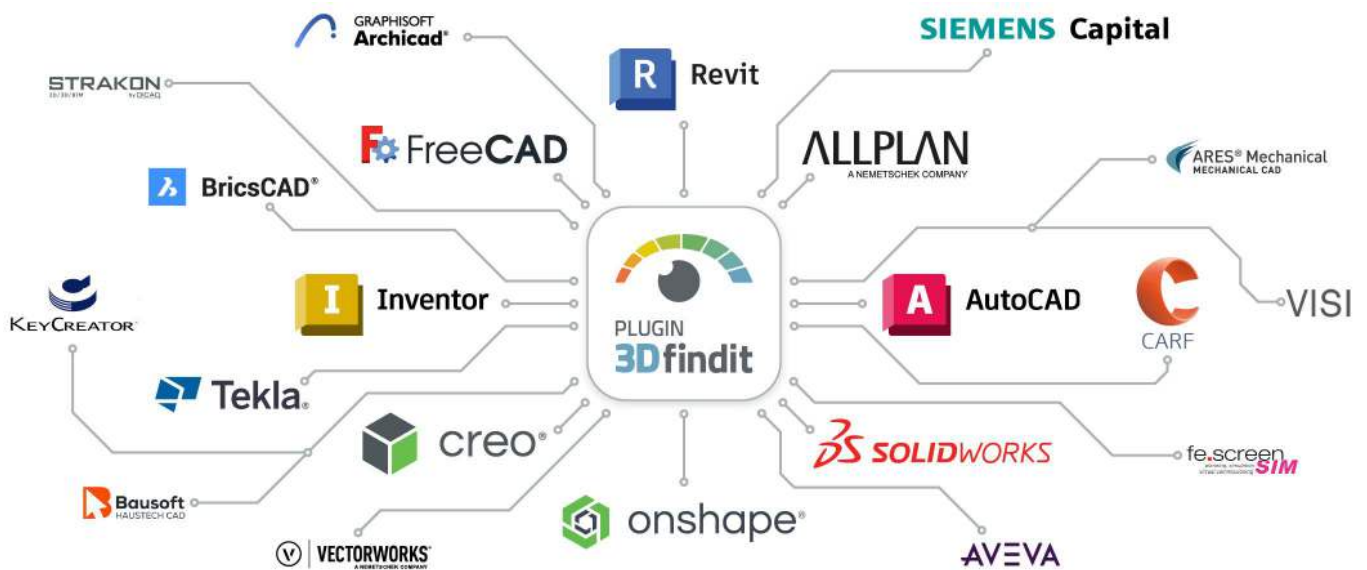

# To the plugins



# 3Dfindit

powered by  CADENAS

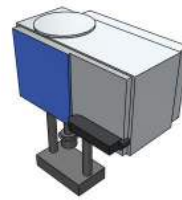

## SIEMENS

### sqv2020p2020

#### 2D derivation

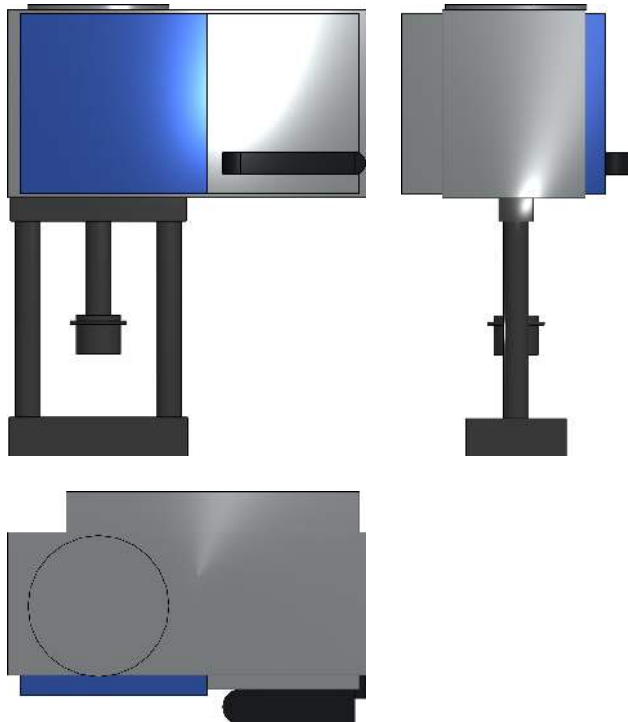

#### ISO view

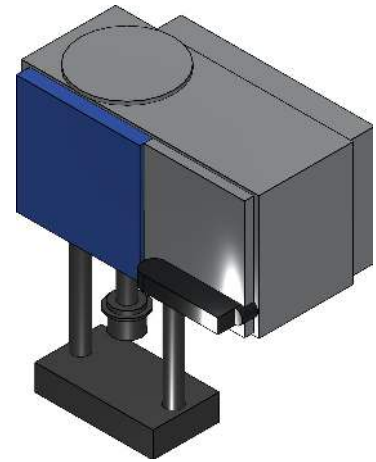

#### Bill-Of-Materials

N°	Description	Amount
1.1	SQV91P30 Ventilantrieb 1100N 40mm(0)	1



**3Dfindit**

powered by  **CADENAS**

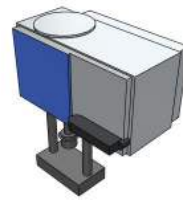

**SIEMENS**

**sqv2020p2020**

Technical drawings



# 3Dfindit

powered by CADENAS

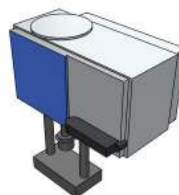

## SIEMENS

### sqv2020p2020

## Technical data

SA010ID04 (Manufacturer's name)	Siemens Building Technologies EUROPEAN Portfolio
SA700ID04 (Product description)	SQV91P30 Valve Actuator 1100N 40mm
SA110ID05 (Type (ASN))	SQV91P30
LODLEVEL (Level of detail)	Low
PREVIEW (Preview)	../../../../_pool_/f7/8d/sqv9120p402fp30.png
BUSPROTOKOLL (Bus protocol)	
SA100ID04 (Actuator type)	electromotive
SA700ID05 (nominal/operating voltage / V)	24
SA700ID06 (type of nominal/operating voltage)	AC
SA700ID09 (nominal frequency (according to DIN EN 50160) / Hz)	50/60
SA700ID12 (maximum power consumption AC (in starting state) / VA)	20
SA700ID29 (Protection class A)	IP66
SA700ID38 (lock against rotation)	no
SA700ID20 (maximum temperature of medium / °C)	120
SA700ID22 (minimum temperature of medium / °C)	1
SA700ID24 (maximum ambient temperature / °C)	55
SA700ID25 (minimum ambient temperature / °C)	0
SA700ID26 (allowable ambient humidity (in operation) / % rF)	95
SA700ID27 (condensation allowable)	no
SA700ID32 (mass (net) / kg)	6.3
SA71006ID04 (Length / mm)	289
SA71006ID05 (Width / mm)	149
SA71006ID06 (Height / mm)	230
LINK ()	<a href="http://www.siemens.com/btproduct?S55150-A130">http://www.siemens.com/btproduct?S55150-A130</a>
SA740ID04 ()	
SA810ID03 (Manufacturer's reference number)	S55150-A130
SA810ID04 (Datanorm number)	S55150-A130
SA810ID06 (GTIN number)	4047625020187
SA810ID10 (Description text)	Electromotoric actuator, 1100 N, 20/40 mm, AC/DC 24 V, 3P / DC 0...10 V / DC 4...20 mA, spring return function, retracted, 120 s
SA810ID14 (Quantity unit)	PCE
SA810ID15 (Quantity per packaging unit)	1
SA810ID16 (Name of the packaging unit)	NMP
SA010ID06 (Manufacturer's web address)	<a href="http://www.siemens.com/buildingtechnologies">http://www.siemens.com/buildingtechnologies</a>



# 3Dfindit

powered by  CADENAS

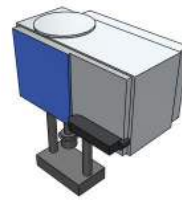

## SIEMENS

SUPPORTLINK (Supportlink)	<a href="https://support.industry.siemens.com/cs/ww/en/ps/25261">https://support.industry.siemens.com/cs/ww/en/ps/25261</a>
SA010ID12 (Status of the manufacturer's catalog)	20210607
ETIMCLASSC (ETIM classcode)	EC011290
ETIMCLASSN (ETIM classname)	Electric servomotor
IFCEXPORT (IfcExportAs)	IfcActuator.USERDEFINED
OMNICLASSNU (OmniClass number)	23-27 33 11
OMNICLASS (OmniClass title)	Electrical Valve Actuators
UNICLASSC (Uniclass code)	Pr_75_50_18_94



# 3Dfindit

powered by  CADENAS

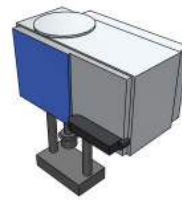

# SIEMENS

## sqv2020p2020

## E-Learning

Discover free training for 3Dfindit, the search engine for engineers, designers, and architects. Our 30 to 50-minute interactive courses provide you with comprehensive knowledge about the platform. Upon successful completion, you will receive a certificate. Start your first course now and master 3Dfindit!

### Become an Expert of Digital Engineering



## 3Dfindit

### Boost your career and get ready for Industry 4.0!

[Learn more](#)

[Start course](#)

[www.CADENAS.de](http://www.CADENAS.de)  
[www.3Dfindit.com](http://www.3Dfindit.com)

◀ VISIT US AT [3Dfindit.com](http://3Dfindit.com) NOW!